

Denison Hydraulic Motors M5* Vane Motor Technology

Pressures up to 320 bar

aerospace
climate control
electromechanical
filtration
fluid & gas handling
hydraulics
pneumatics
process control
sealing & shielding



ENGINEERING YOUR SUCCESS.

Content

GENERAL	Warning	2
	General characteristics	3
	Description	4
	Ports and hydraulic fluids.....	5
	Motor selection	6
	Fluid power formulas	6
	Performance data	7
	Max. ratings	8 - 9
M5AF / M5AF1	Ordering code and technical data	10
	Dimensions	11
M5B / M5BS	Ordering code and technical data	12
	Dimensions	13
M5BF / M5BF1	Ordering code and technical data	14
	Dimensions	15



WARNING — USER RESPONSIBILITY

FAILURE OR IMPROPER SELECTION OR IMPROPER USE OF THE PRODUCTS DESCRIBED HEREIN OR RELATED ITEMS CAN CAUSE DEATH, PERSONAL INJURY AND PROPERTY DAMAGE.

- This document and other information from Parker-Hannifin Corporation, its subsidiaries and authorized distributors provide product or system options for further investigation by users having technical expertise.
- The user, through its own analysis and testing, is solely responsible for making the final selection of the system and components and assuring that all performance, endurance, maintenance, safety and warning requirements of the application are met. The user must analyze all aspects of the application, follow applicable industry standards, and follow the information concerning the product in the current product catalog and in any other materials provided from Parker or its subsidiaries or authorized distributors.
- To the extent that Parker or its subsidiaries or authorized distributors provide component or system options based upon data or specifications provided by the user, the user is responsible for determining that such data and specifications are suitable and sufficient for all applications and reasonably foreseeable uses of the components or systems.

Offer of Sale

Please contact your Parker representation for a detailed "Offer of Sale".

LOW NOISE MOTOR

12 vanes and a patented cartridge design allows a very low noise level, whatever the speed.

HIGH PERFORMANCE MOTOR

The M5 series have been designed especially for severe duty applications which require high pressure, high speed and low fluid lubricity.

Max. pressure (intermittent)

M5A* 006 to 018	: 300 bar
M5A* 023 - 025	: 280 bar
M5B* 012 to 036	: 320 bar
M5B* 045	: 280 bar

Max. speed (intermittent, low loaded cond.)

M5A* 006 to 018	: 4000 RPM
M5A* 023 - 025	: 3000 RPM
M5B* 012 - 018	: 6000 RPM
M5B* 023 - 028 - 036.....	: 4000 RPM
M5B* 045	: 3000 RPM

HIGH EFFICIENCY

Up to 90 % overall at 300 bar for M5A* and 320 bar for M5B*. Vane motors begin life with a high volumetric efficiency, and maintain that efficiency throughout their operating life. Vane pin holdout design improves the mechanical efficiency at low pressure.

HIGH STARTING TORQUE

The high starting torque efficiency of the vane type motors allows them to start under high load without pressure overshoots, jerks and high instantaneous horsepower loads.

LOW TORQUE RIPPLE

This 12 vane type motor exhibits a very low torque ripple (typical $\pm 1,5\%$), even at low speeds.

HIGH LIFETIME

The vane, rotor and cam ring are pressure balanced to increase life over the full speed range. Double lip vanes reduce the sensitivity to fluid pollution.

INTERCHANGEABLE ROTATING GROUPS

Our precise manufacturing allows any component to be interchangeable. Rotating groups may be easily replaced to renew the motor or change the displacement to suit altered requirements for speed or torque.

ROTATION AND DRAIN

The M5B-M5BS are bi-directional motors, externally drained. The M5AF and M5BF, externally drained, are available in three types of rotation : bi-directional, clockwise, counter-clockwise. The M5AF1 and M5BF1, internally drained, are available in two types of rotation : clockwise, and counter-clockwise.

CROSS PORT CHECK VALVE

The uni-directional M5AF, M5AF1, M5BF and M5BF1 are designed with an internal valve that allows smooth dynamic braking, with a very simple hydraulic circuit and without risk of motor cavitation.

MOUNTING

M5B - M5BS : Cylindrical keyed or splined shaft according to SAE J744, ISO 3019-2 or J498.

These products are designed primarily for coaxial drives which do not impose axial or side loading on the shaft.

M5AF - M5AF1 : Cylindrical keyed or taper shaft, and a high load capacity double ball bearing allows the direct mounting on shaft (fan, ...).

M5BF - M5BF1 : A stiff taper or cylindrical keyed shaft and a high load capacity double ball bearing allow the direct mounting on shaft (fan, ...).

Vane Motors M5A* / M5B*

Description

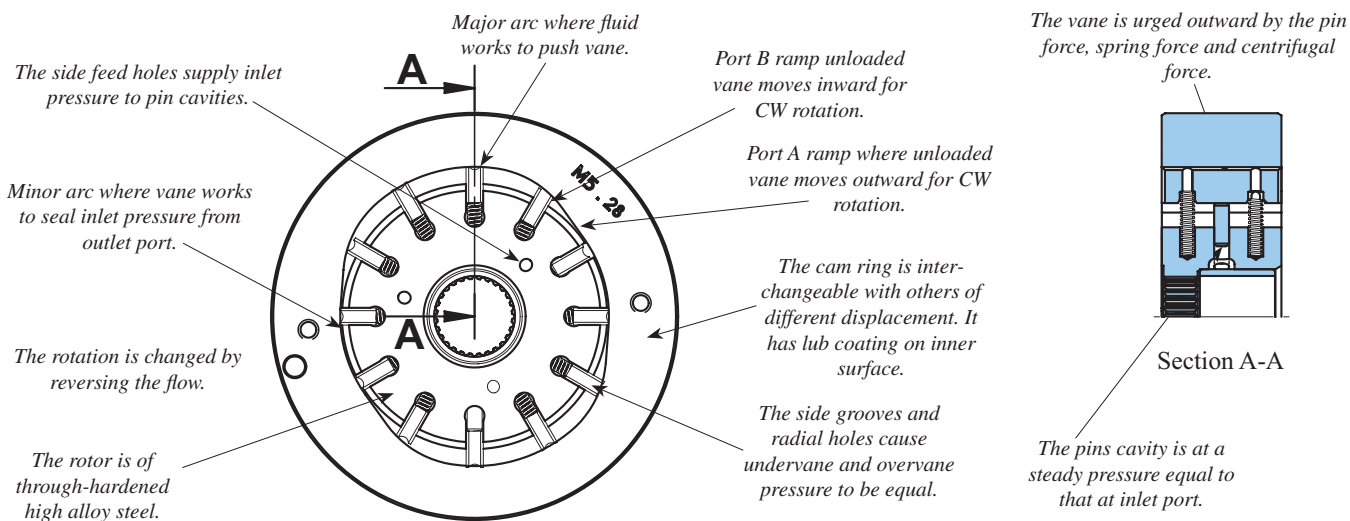
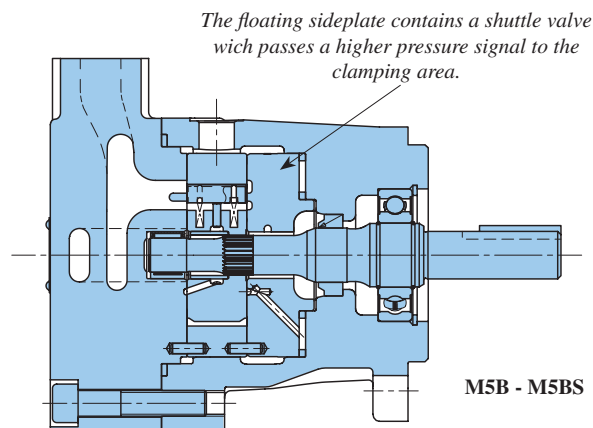
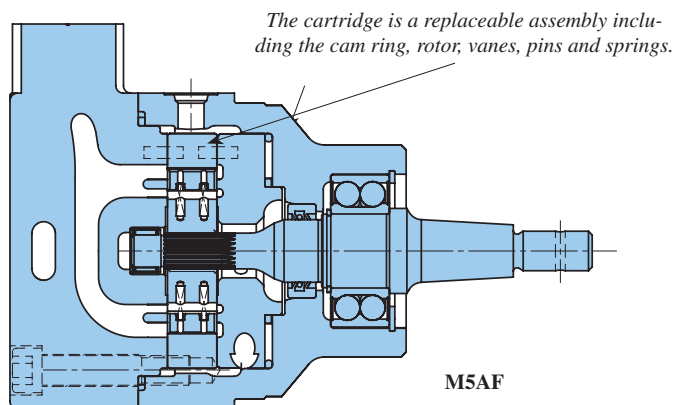

OPERATION - SINGLE CARTRIDGE

- The motor shaft is driven by the rotor. Vanes, closely fitted into the rotor slots move radially to seal against the cam ring. The ring has two major and two minor radial sections joined by transitional sections called ramps. These contours and the pressures exposed to them are balanced diametrically.
- Hydraulic pins and light springs urge the vanes radially against the cam contour assuring a seal at zero speed so that the motor can develop starting torque. The springs and pins are assisted by centrifugal force at higher speeds. Radial grooves and holes through the vanes equalize radial hydraulic forces on the vanes at all times. Fluid enters and leaves the motor cartridge through opening in the side plates at the ramps. Each motor port connects to two diametrically opposed ramps. Pressurized fluid entering at Port A torques the rotor clockwise. The rotor transports it to the ramp openings which connect to Port B from which it returns to the low pressure side of the system. Pressure at Port B torques the rotor counter-clockwise.
- The rotor is separated axially from the sideplate surface by the fluid film. The front sideplate is clamped against the cam ring by the pressure, maintains optimum clearance as dimensions change with temperature and pressure. A 3-way shuttle valve in the sideplate causes clamping pressure in Port A or B, whichever is the highest.
- Materials are chosen for long life efficiency. The vanes, rotor and cam ring are made out of hardened high alloy steels. Cast semi-steel sideplates are chemically etched to have a fine crystalline surface for good lubrication at start-up.

EXTERNAL DRAIN MOTOR

This motor may be alternately pressurized on ports A and B to 300 bar max. int. (280 bar for 025) for M5AF and 320 bar max. int. (280 bar for 045) for M5BF. Whichever port is at low pressure, it should not be subjected to more than 60% of the high pressure, eg. for M5B* : When 320 bar in A, B is limited to 200 bar. This motor must have a drain line connected to the center housing drain connection of sufficient size to prevent back pressure in excess of 3,5 bar, and returned to the reservoir below the surface of the oil as far away as possible from the suction pipe of the pump.

INTERNAL DRAIN MOTOR

This unidirectional motor may be pressurized only on the port corresponding to its rotation type. The outlet pressure must not be higher than 3,5 bar.

RECOMMENDED FLUIDS

Petroleum base anti-wear R & O fluids (covered by Parker HF-0 and HF-2 specifications). Maximum catalog ratings and performance data are based on operation with these fluids.

FIRE RESISTANT FLUIDS

They are easily used in the M5A* and M5B* motors. These include phosphate or organic ester fluids and blends, water-glycol solutions and water-oil invert emulsions.

ACCEPTABLE ALTERNATE FLUIDS

The use of fluids other than petroleum base anti-wear R & O fluids requires that the maximum ratings of the motor will be reduced. In some cases, the minimum replenishment pressure must be increased.

- HF-1 : non antiwear petroleum base.
- HF-3 : water in oil invert emulsion.
- HF-4 : water glycols solutions.
- HF-5 : synthetic fluids.

Model of motor	Maximum speed RPM	Maximum pressure			
		HF-1, HF-4, HF-5		HF-3	
		Int.	Cont.	Int.	Cont.
		bar	bar	bar	bar
M5A*	1500	225	195	165	130
M5B*	1800	240	210	175	140

VISCOSITY

Max. (cold start, low speed and pressure) 860 mm²/s (cSt)
 Max. (full speed and pressure) 100 mm²/s (cSt)
 Optimum (max. lifetime) 30 mm²/s (cSt)
 Min. (full speed and pressure, HF-1 fluid) 18 mm²/s (cSt)
 Min. (full speed and pressure, HF-0 & HF-2 fluids) 10 mm²/s (cSt)
 For cold starts, the motor should operate at low speed and pressure until fluid warms up to an acceptable viscosity for full power operation.

VISCOSITY INDEX

90 min.
 Higher values extend the range of operating temperatures and lifetime.

TEMPERATURE

Max. fluid temperature (HF-0, HF-1 & HF-2) + 100° C
 Min. fluid temperature (HF-0, HF-1 & HF-2) - 18° C

FLUID CLEANLINESS

The fluid must be cleaned before and during operation to maintain a contamination level of NAS 1638 class 8 (or ISO 19/17/14) or better. Filters with 25 micron (or better, β10 ≥ 100) nominal ratings may be adequate but do not guarantee the required cleanliness levels.

WATER CONTAMINATION IN FLUID

Maximum acceptable content of water is :
 • 0,10 % for mineral base fluids.
 • 0,05 % for synthetic fluids, crankcase oils, biodegradable fluids.
 If amount of water is higher, then it should be drained off the circuit.

Motor selection

Motor performances required

Torque..... T [Nm.]	110
Speed..... n [RPM]	1500

Pump available data

Flow q _{ve} [l/min]	55
Pressure..... P [bar]	280

Check if available power is greater than required power (0.85 estimated overall efficiency).

$$0.85 \times \frac{q_{ve} \times p}{600} \geq \frac{T \times \pi \times n}{30 \times 1000} \qquad 0.85 \times \frac{55 \times 280}{600} \geq \frac{110 \times \pi \times 1500}{30 \times 1000}$$

$$21,8 > 17,3 \text{ kW}$$

Two ways of calculation : Calculate V_i from T required torque, or from q_{ve} available flow.

2a.

$$V_i = \frac{20 \times \pi \times T}{p} = \frac{20 \times \pi \times 110}{280} = 24,7 \text{ ml/rev.}$$

3a. Choose motor from V_i immediately greater
M5B* 028 : V_i = 28,0 ml/rev.

4a. Check theoretical motor pressure

$$p = \frac{20 \times \pi \times T}{V_i} = \frac{20 \times \pi \times 110}{28,0} = 247 \text{ bar}$$

Torque loss at this pressure = 9,5 Nm
(See page 12)
Calculate real pressure

$$p = \frac{20 \times \pi \times (T + Tl)}{V_i} = \frac{20 \times \pi \times 119,5}{28,0} = 268 \text{ bar}$$

5a. Flow loss at this pressure : 5 l/min
(See page 12)
Real flow used by the motor :
55 - 5 = 50 l/min

6a. Real speed of the motor :

$$n = \frac{q_v \times 1000}{V_i} = \frac{50 \times 1000}{28,0} = 1785 \text{ RPM}$$

Real performances
V_i = 28,0 ml/rev.
n = 1785 RPM
T = 110 Nm.
p = 268 bar

2b.

$$V_i = \frac{1000 \times q_{ve}}{n} = \frac{1000 \times 55}{1500} = 36,7 \text{ ml/rev.}$$

3b. Choose motor from V_i immediately smaller
M5B* 036 : V_i = 36,0 ml/rev.

4b. Check theoretical motor pressure with
T = 110 Nm.

$$p = \frac{20 \times \pi \times T}{V_i} = \frac{20 \times \pi \times 110}{36,0} = 192 \text{ bar}$$

Torque loss at this pressure = 8,0 Nm
(See page 12)
Calculate real pressure

$$p = \frac{20 \times \pi \times (T + Tl)}{V_i} = \frac{20 \times \pi \times 118}{36,0} = 206 \text{ bar}$$

5b. Flow loss at this pressure : 4 l/min
(See page 12)
Real flow used by the motor :
55 - 4 = 51 l/min

6b. Real speed of the motor :

$$n = \frac{q_v \times 1000}{V_i} = \frac{51 \times 1000}{36,0} = 1416 \text{ RPM}$$

Real performances
V_i = 36,0 ml/rev.
n = 1416 RPM
T = 110 Nm.
p = 206 bar

FLUID POWER FORMULAS

Volumetric efficiency	$\frac{1}{1 + \frac{\text{total leakage} \times 1000}{\text{speed} \times \text{displacement}}}$	Speed	[tr/min]
		Displacement	[cm ³ /tr]
		Pressure	[bar]
		Flow rate	[l/min]
		Leakage	[l/min]
		Torque	[Nm]
		Torque loss	[Nm]
Fluid motor speed	rpm $\frac{1000 \times \text{flow rate} \times \text{volumetric eff.}}{\text{displacement}}$		
Fluid motor torque	N.m $\frac{\Delta \text{ pressure} \times \text{displacement} \times \text{mech. eff.}}{20 \times \pi}$		
Fluid motor power	kW $\frac{\text{speed} \times \text{displacement} \times \Delta \text{ pressure} \times \text{overall eff.}}{600 \ 000}$		
	kW $\frac{\text{torque} \times \text{speed} \times 20 \times \pi}{600 \ 000}$		

Performance data

	Mounting flange	Ports	Drain	Shaft ends
M5AF	Special mounting (2 bolts - Ø 120)	SAE 3/4" - 4 bolts UNC or SAE 3/4" - 4 bolts metric (ISO/DIS 6162 - SAE J518)	ISO 6149 - M12 x 1,5 or SAE 6 - J1926 - SAE 9/16"	Keyed taper non SAE Keyed non SAE
M5AF1		SAE 12 1"1/16 - 12 UNF-2B J1926 or ISO 6149 - M22 x 1,5)	No drain connection	
M5B	ISO 3019-2 100 A2/B4 HW (2/4 bolts - Ø 100)	SAE 3/4" - 4 bolts UNC or	M18 x 1,5	Keyed cyl. SAE "B" Keyed cyl. ISO E 25M Splined SAE "B" Splined SAE "BB"
M5BS	SAE "B" J744 (2/4 bolts - Ø 101,6)	SAE 3/4" - 4 bolts metric (ISO/DIS 6162 SAE J518)	M18 x 1,5 or SAE 9/16"	
M5BF	Special mounting (2 bolts - Ø 135)	SAE 3/4" - 4 bolts metric (ISO/DIS 6162 SAE J518)	No drain connection	Keyed taper non SAE
M5BF1				Keyed cyl. SAE "C" Keyed cyl. ISO G32N

Series	Theoretical displacement	Theoretical torque	Theoretical power at 100 RPM	Typical data 2000 RPM - 300 bar	
	ml/rev	N.m/bar	kW/bar	N.m	kW
M5A*	6,3	0,100	0,0011	26,1	5,5
	10,0	0,159	0,0017	43,7	9,2
	12,5	0,199	0,0021	55,7	11,7
	16,0	0,255	0,0027	72,4	15,2
	18,0	0,286	0,0030	81,2	17,0
	23,0	0,366	0,0038	102,5 ¹⁾	21,5 ¹⁾
	25,0	0,398	0,0042	107,4 ¹⁾	22,5 ¹⁾

¹⁾ 023 - 025 = 280 bar max.

Series	Theoretical displacement	Theoretical torque	Theoretical power at 100 RPM	Typical data 2000 RPM - 320 bar	
	ml/rev	N.m/bar	kW/bar	N.m	kW
M5B*	12,0	0,191	0,0020	50,6	10,6
	18,0	0,286	0,0030	81,2	17,0
	23,0	0,366	0,0038	117,1	24,5
	28,0	0,446	0,0047	132,1	27,7
	36,0	0,572	0,0060	172,8	36,2
	45,0	0,716	0,0075	190,0 ¹⁾	39,8 ¹⁾

¹⁾ 045 = 280 bar max.

STARTING PERFORMANCES

Typical data at 24 cSt / 45° C

	M5A*	M5B*
Maximum cross-flow 100 bar :	0,6 l/min	1,8 l/min
200 bar :	7,4 l/min	7,8 l/min
320 bar :	10,7 l/min ¹⁾	12,5 l/min

¹⁾ 300 bar

Minimum stalled torque efficiency for M5B* only	100 bar : 78,3 %
	200 bar : 81,0 %
	320 bar : 80,8 %

PERMISSIBLE AXIAL AND RADIAL LOADS M5BF

1 - Max. axial load : Fa max. = 6 000 N

2 - Max. radial load cylindrical shaft : Fr max. = 8 000 N

taper shaft : Fr max. = 5 500 N

3 - Theoretical lifetime [hour] : $L_{10H} [hour] = \frac{16\ 666}{N [rpm]} \times L_{10}$

4 - Theoretical lifetime [10⁶ rev] : L₁₀

5 - Eg of theoretical life time calculation

Axial load	Fa = 2000 N
Radial load	Fr = 1000 N
Operating speed	N = 2000 RPM
L10 = 2000 [10 ⁶ rev] (see on curve page 14).	

$$L_{10H} = \frac{16\ 666}{2000} \times 2000 \quad L_{10H} = 16\ 666 \text{ hours.}$$

006 - 010 - 012 - 016 - 018

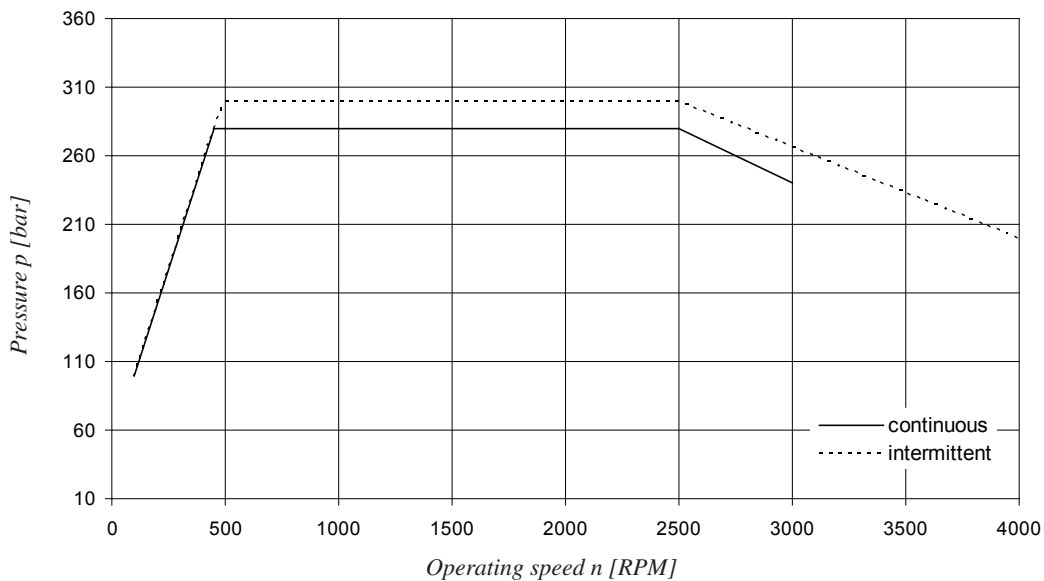

023 - 025

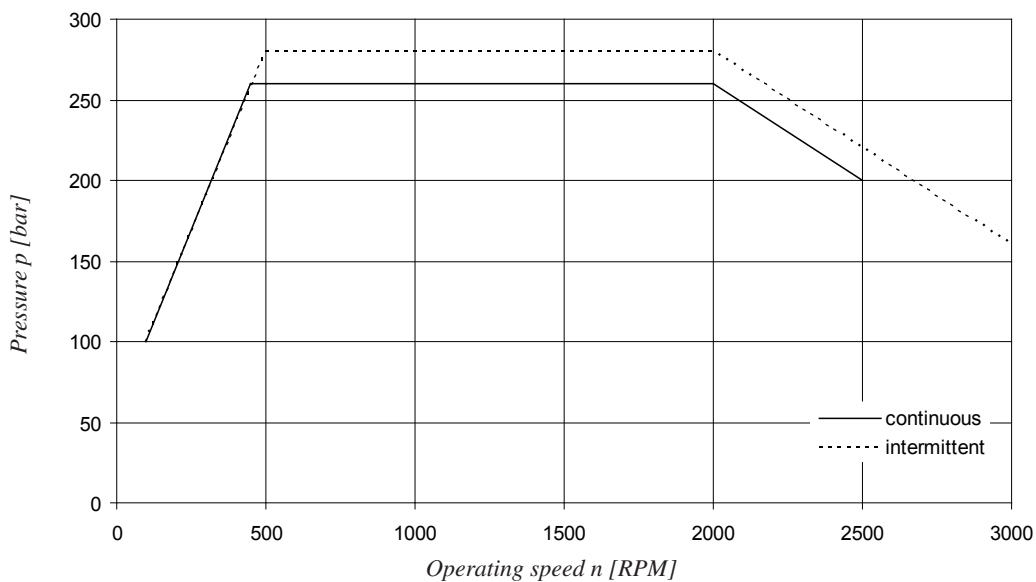

- These are running condition limits; for starting performances see page 7.
- Intermittent conditions : do not exceed 6seconds per minute of rotation.
- Typical curves, at 24 cSt 45° C.
- For higher specifications or for operating speed under 100 RPM, please consult our technical department.

012 - 018

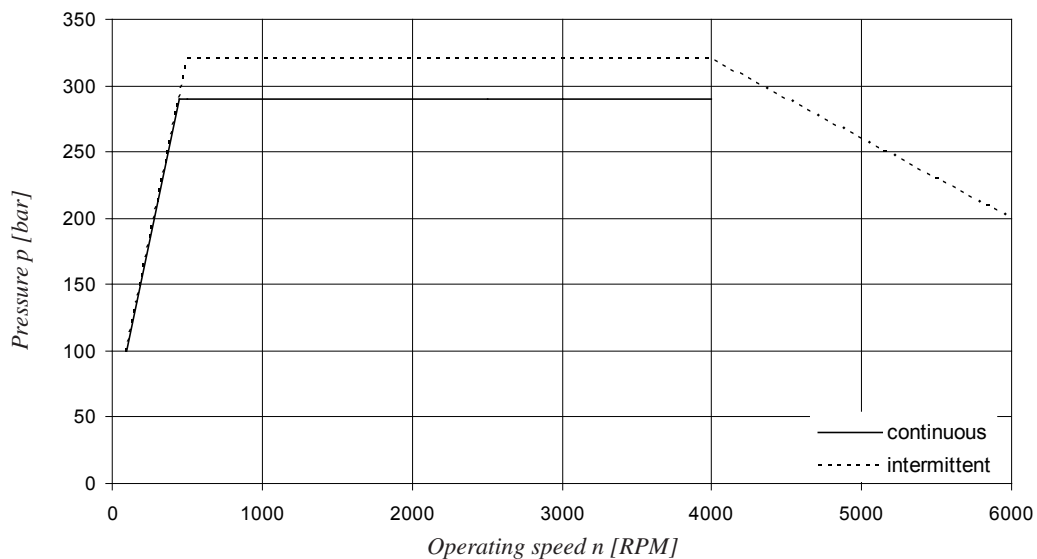

023 - 028 - 036

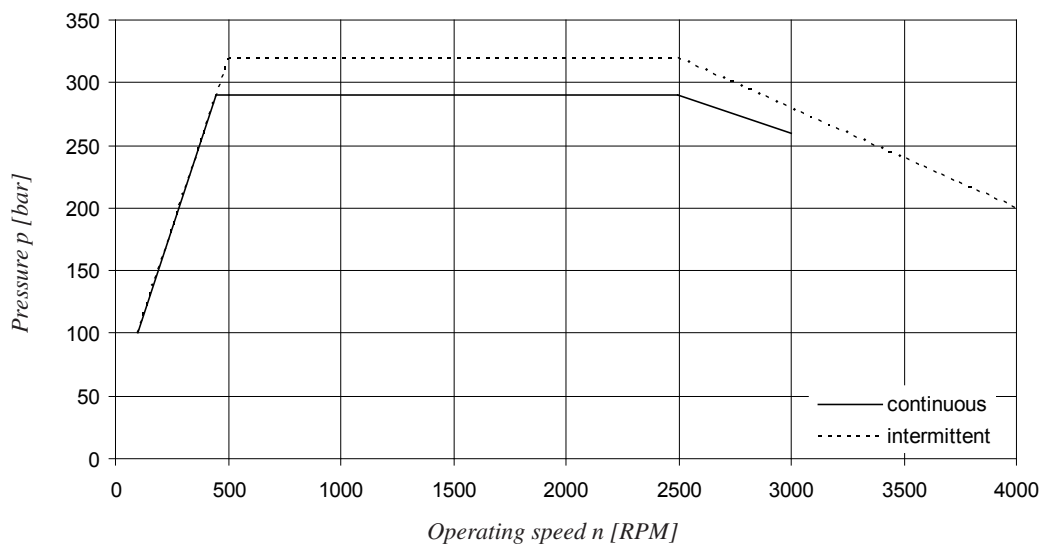

045

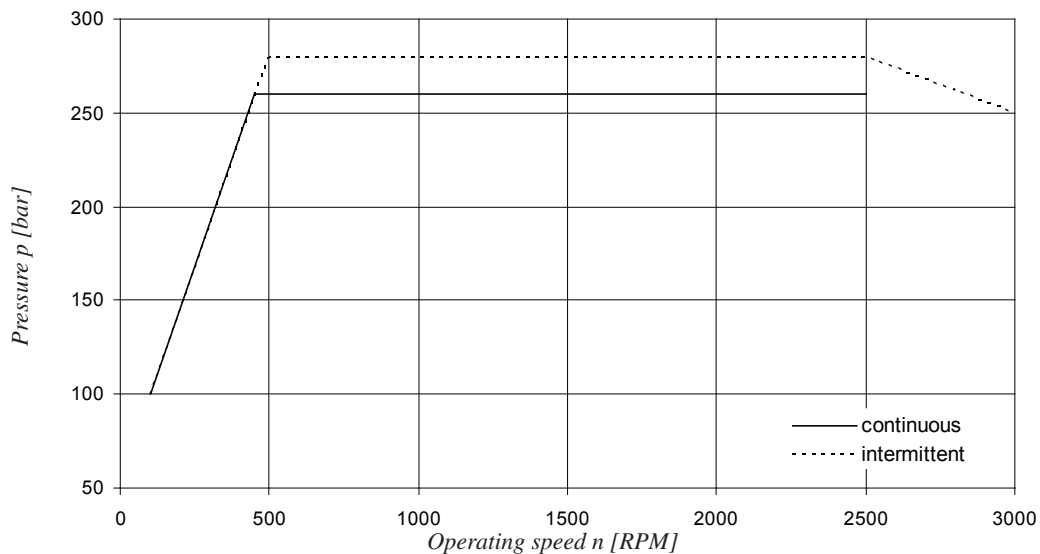

- These are running condition limits; for starting performances see page 7.
- Intermittent conditions : do not exceed 6seconds per minute of rotation.
- Typical curves, at 24 cSt 45° C.
- For higher specifications or for operating speed under 100 RPM, please consult our technical department.

Model No.

M5AF1 - 018 - 1 N 02 - B 1 - M 3 - AP2i

M5AF series External drain

M5AF1 series Internal drain

Displacement

Volumetric displacement (ml/rev.)

006 = 6,3 018 = 18,0
010 = 10,0 023 = 23,0
012 = 12,5 025 = 25,0
016 = 16,0

Type of shaft

1 = taper (non SAE)
2 = keyed (non SAE)

Direction of rotation (view on shaft end) - M5AF - M5AF1

R = Clockwise
L = Counter-clockwise

Direction of rotation (view on shaft end) - M5AF

N = Bi-rotational

Porting combination

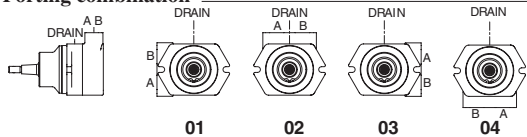

Modifications or special option

Ex. : AP21 = Anti-starve valve + proportional pressure relief valve set at 210 bar.
For a flow above 75 l/min a special cap is needed, please consult Parker.

Drain variables - M5AF

2 = 9/16" 18 - SAE drain
3 = M12 x 1,5 metric drain

Drain variables - M5AF1

X = no drain connection

End cap variables - All motors except with proportional pressure relief valve ¹⁾

M = 3/4" - 4 bolts SAE flange J518 - Metric thread
0 = 3/4" - 4 bolts SAE flange J518 - UNC thread
Y²⁾ = Metric threaded ports (ISO 6149) - M22 x 1,5
W²⁾ = SAE str. threaded ports - 1"1/16-12 UNF-2B

Seal class

1 = S1 BUNA N 5 = S5 - VITON®

Design letter

¹⁾ For other end cap variables, please contact Parker.

²⁾ Anti-starve valve not available.

ROTATION = BI-ROTATIONAL (N)

View from shaft end :

CW rotation A = inlet
 B = outlet
CCW rotation A = outlet
 B = inlet

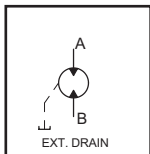

R OR L ROTATION (New rotation concept - patent pending)³⁾

View from shaft end :

CW & CCW rotations
A = inlet
B = outlet

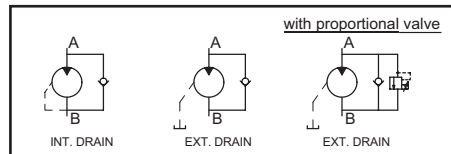

OVERALL LEAKAGE (internal + external)

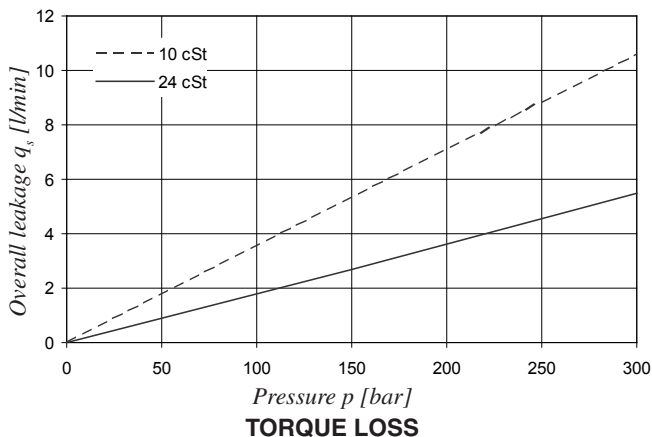

NOISE LEVEL - M5AF 025

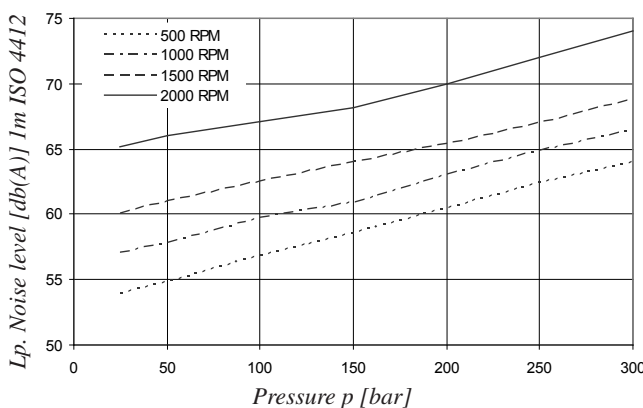

TORQUE LOSS

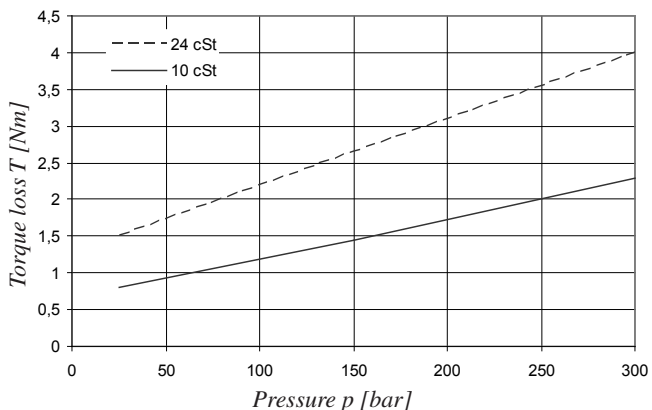

PERMISSIBLE AXIAL AND RADIAL LOADS

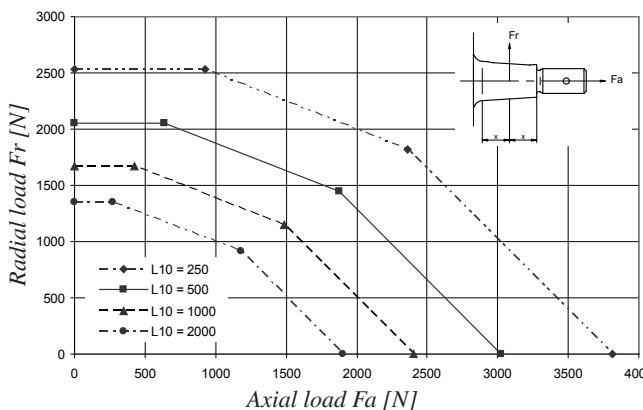

³⁾ L or R rotation is a new internal concept : A is always «in» and B always «out».

L10 = Theoretical lifetime [10⁶ rev.]

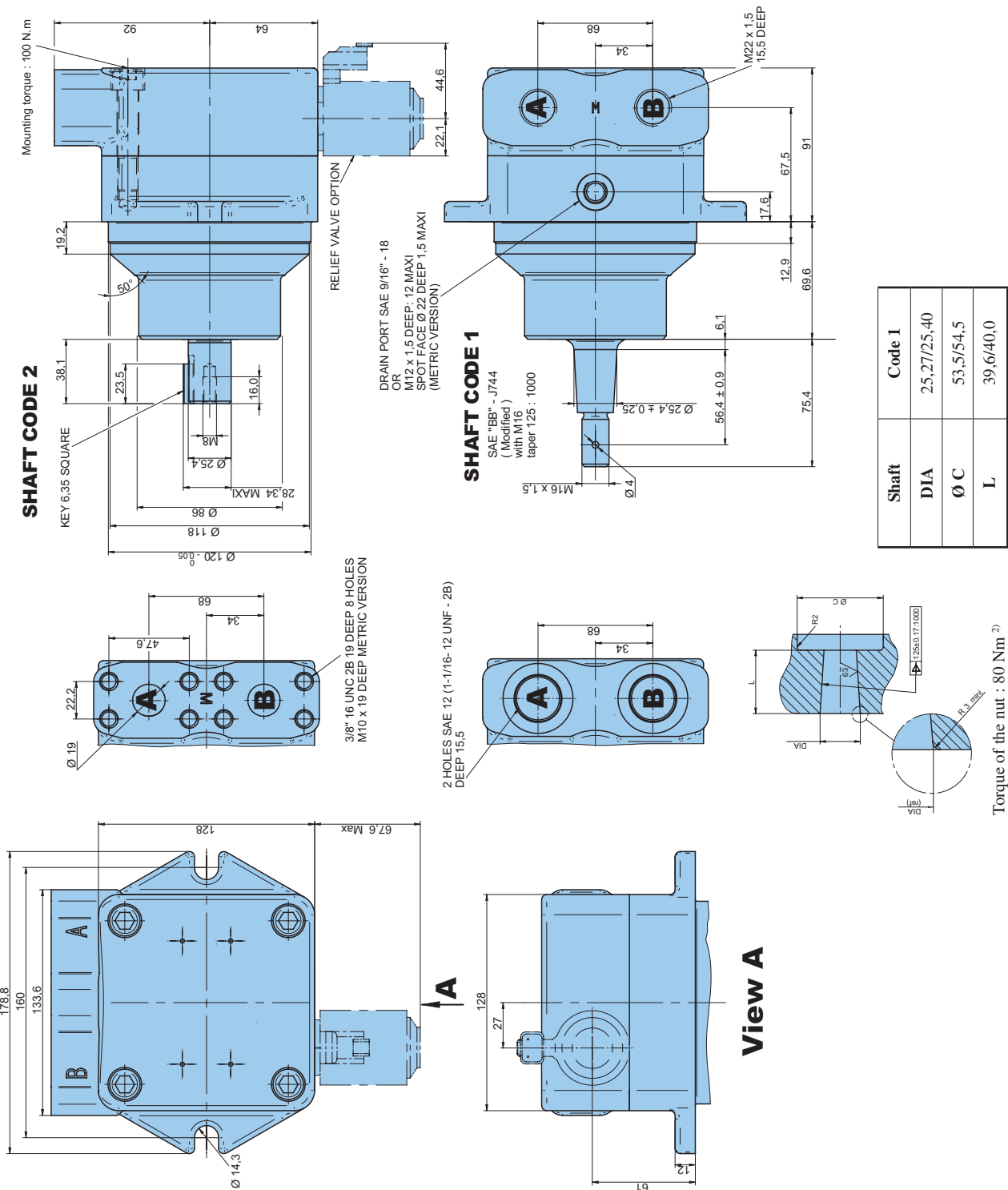

Shaft	Code 1
DIA	25,27/25,40
Ø C	53,5/54,5
L	39,6/40,0

PERFORMANCES : PRESSURE & SPEED

Displacement	006	010	012	016	018	023	025
Pressure max (bar)			300				280
Speed max (RPM)			4000				2500

MINIMUM REPLENISHMENT PRESSURE (BAR ABSOLUTE AT THE B PORT) for M5AF with an internal check valve¹⁾

Flow (l/min)	5	10	20	30	40	50	60
Min pressure (bar)	1,3	1,8	2,5	3,0	4,2	6,2	9,0

¹⁾ 60 l/min is the maximum flow allowed through the internal check valve.

²⁾ This torque is for a steel coupling and a nut of at least grade 8.8 quality. It is compulsory to install a castle nut and cotter pin for right-hand rotation - bi-rotational.

Model No.

M5BS - 036 - 1 N 02 - B 1 - M 3 - ..

M5B series External drain

ISO 3019-2 - 100 A2/B4 HW

M5BS series External drain

SAE B - J744

Displacement

Volumetric displacement (ml/rev.)

012 = 12,0 028 = 28,0

018 = 18,0 036 = 36,0

023 = 23,0 045 = 45,0

Type of shaft

1 = keyed (SAE B)

2 = keyed (ISO E25M)

3 = splined (SAE B)

4 = splined (SAE BB)

Direction of rotation (view on shaft end)

N = Bi-rotational

Modifications

Drain variables - M5BS

2 = 9/16" 18 SAE drain

3 = M18 x 1,5 metric drain

Drain variables - M5B

3 = M18 x 1,5 metric drain

End cap variables

M = 3/4" - 4 bolts SAE flange J518 - Metric thread

0 = 3/4" - 4 bolts SAE flange J518 - UNC thread

Seal class

1 = S1 - BUNA N

5 = S5 - VITON®

Design letter

Porting combination

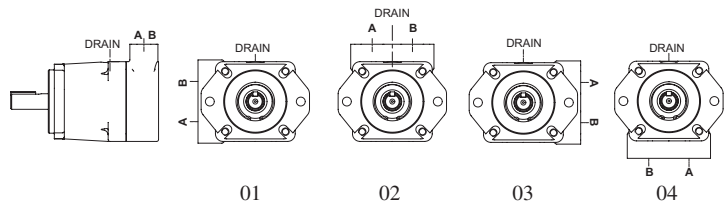

ROTATION = BI-ROTATIONAL (N)

View from shaft end :

CW rotation

A = inlet

B = outlet

CCW rotation

A = outlet

B = inlet

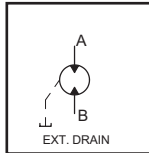

OVERALL LEAKAGE (internal + external)

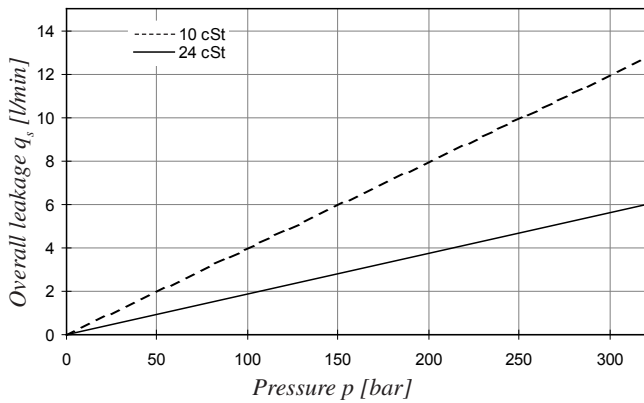

TORQUE LOSS

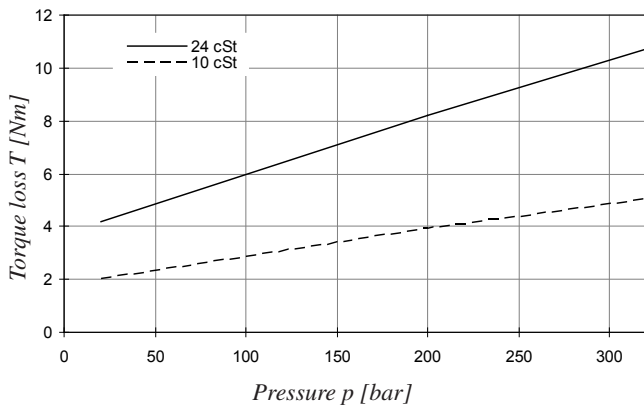

NOISE LEVEL - M5BS - 036

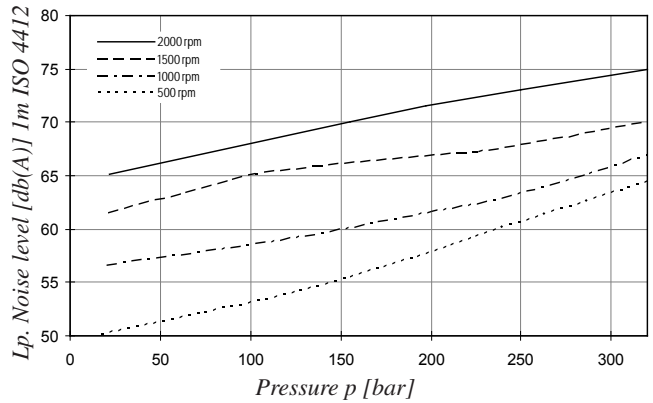

PERMISSIBLE AXIAL AND RADIAL LOADS

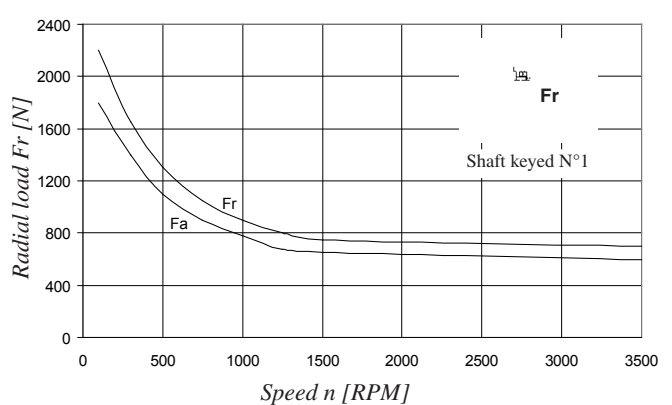

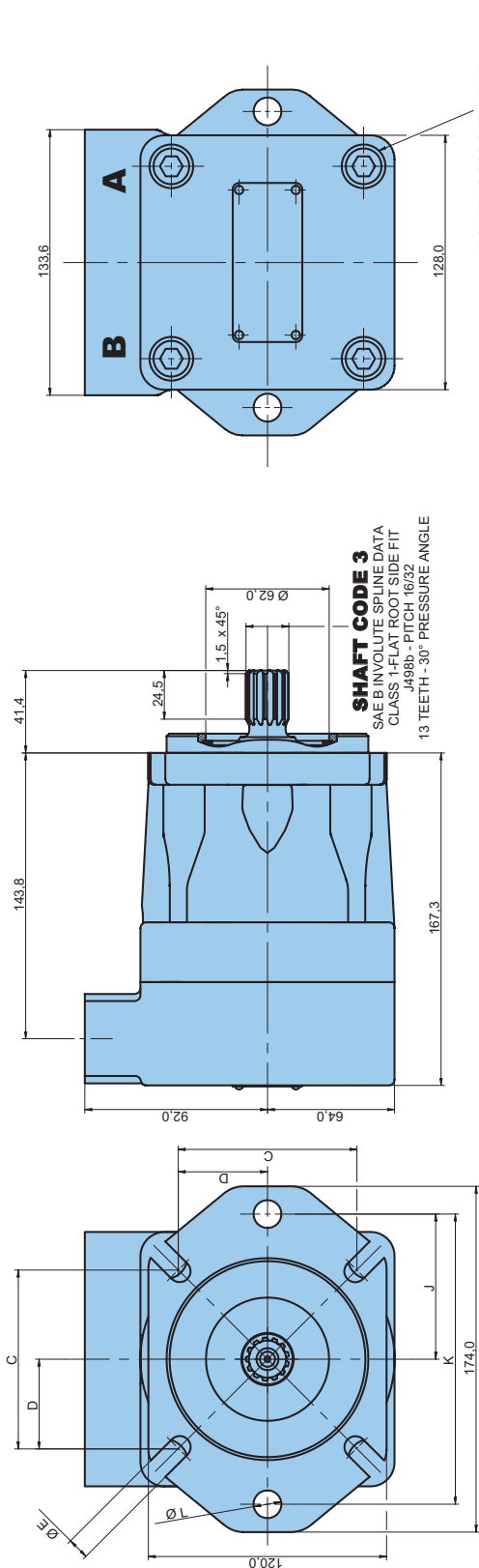

MOUNTING TORQUE : 100 N.m

SHAFT CODE 3
SAE B INVOLUTE SPLINE DATA
CLASS 1-FLAT ROOT SIDE FIT
J498b - PITCH 16/32
13 TEETH - 30° PRESSURE ANGLE

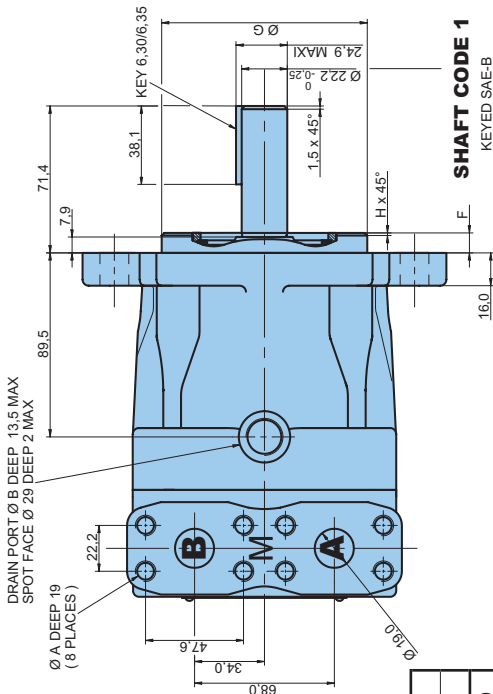

DRAIN PORT Ø B DEEP 13.5 MAX
SPOT FACE Ø 29 DEEP 2 MAX

SHAFT CODE 1
KEYED SAE-B

SHAFT CODE 2
KEYED ISO E25M

SAE BB INVOLUTE SPLINE DATA
CLASS 1-FLAT ROOT SIDE FIT
J498b - PITCH 16/32
15 TEETH - 30° PRESSURE ANGLE

Port code	M5BS		M5B	
	0	M	0	M
Ø A	3/8" - 16 UNC	M10	3/8" - 16 UNC	M10
Drain code	2	3	3	
Ø B	SAE 9/16" - 18	M18 x 1.5	M18 x 1.5	
C	88,9		88,4	
D	44,9		44,2	
Ø E	14,3		11,0	
F	9,7		9,0	
Ø G	101,6		100 h8	
H	1,5		2,0	
J	73,0		70,0	
K	146,0		140,0	
Ø L	14,3		14,0	

Model No. M5BF1 - 036 - 1 N 02 - B 1 - M 3 - AP21

M5BF series External drain
M5BF1 series Internal drain

Displacement
Volumetric displacement (ml/rev.)
012 = 12,0 028 = 28,0
018 = 18,0 036 = 36,0
023 = 23,0 045 = 45,0

Type of shaft
1 = keyed taper (non SAE)
2 = keyed (SAE C)
W = keyed (ISO G32N)

Direction of rotation (view on shaft end) - M5BF - M5BF1
R = Clockwise
L = Counter-clockwise

Direction of rotation (view on shaft end) - M5BF
N = Bi-rotational

Porting combination

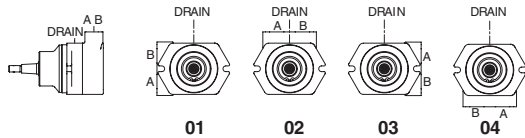

Modifications or special option

Ex. : AP21 = Anti-starve valve + proportional pressure relief valve set at 210 bar.
For a flow above 75 l/min a special cap is needed, please consult Parker.

Drain variables - M5BF

2 = 9/16" 18 SAE drain
3 = M18 x 1,5 metric drain
Drain variables - M5BF1
x = no drain connection

End cap variables M5BF

M = 3/4" - 4 bolts SAE flange J518 - Metric thread
0 = 3/4" - 4 bolts SAE flange J518 - UNC thread

End cap variables M5BF1

M = 3/4" - 4 bolts SAE flange J518 - Metric thread

Seal class

1 = S1 - BUNA N
5 = S5 - VITON®

Design letter

ROTATION = BI-ROTATIONAL (N)

View from shaft end :

CW rotation A = inlet
 B = outlet
CCW rotation A = outlet
 B = inlet

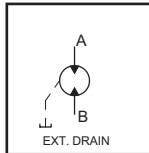

R OR L ROTATION (New rotation concept - patent pending)¹⁾

View from shaft end :

CW & CCW rotations
A = inlet
B = outlet

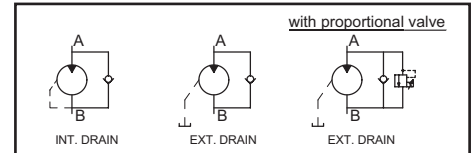

OVERALL LEAKAGE (internal + external)

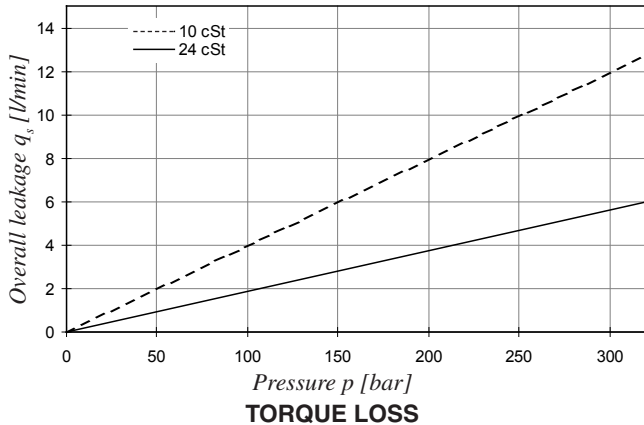

TORQUE LOSS

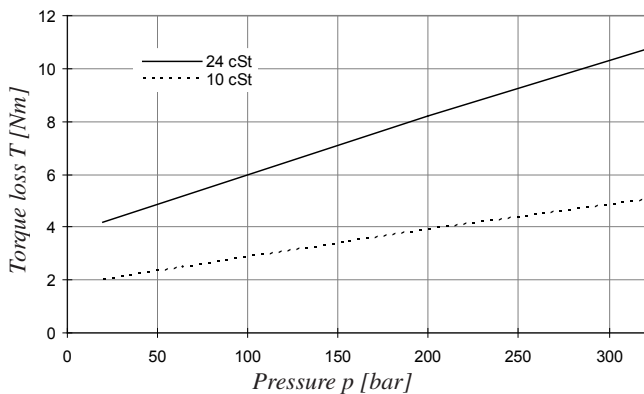

NOISE LEVEL - M5BF - 036

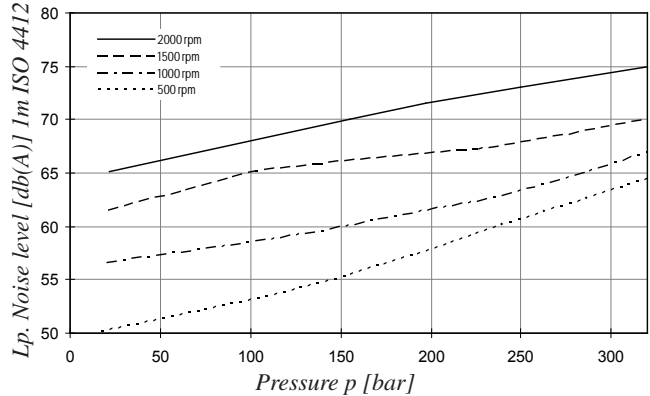

PERMISSIBLE AXIAL AND RADIAL LOADS

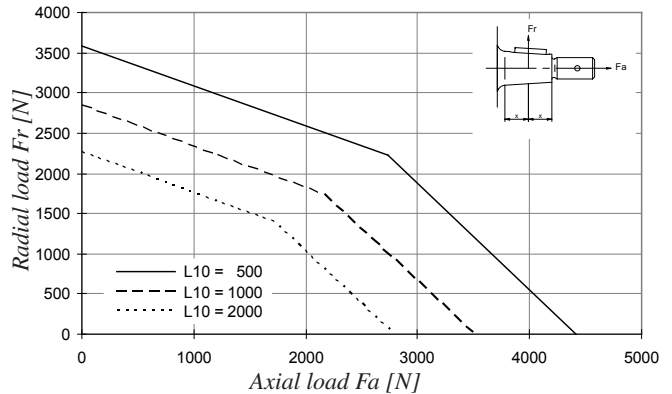

¹⁾ L or R rotation is a new internal concept : A is always "in" and B always "out".

L10 = Theoretical lifetime [10⁶ rev.]

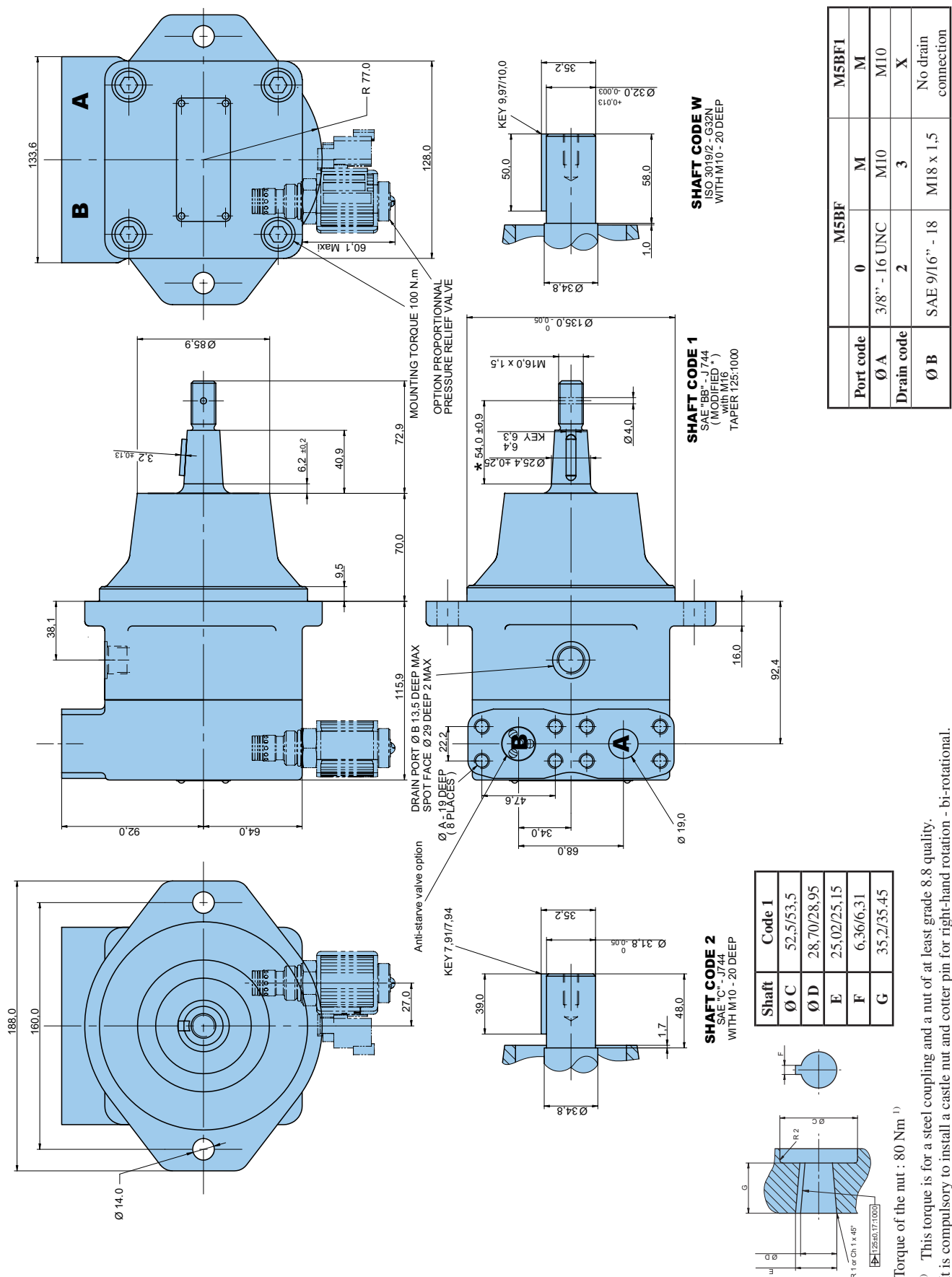

¹⁾ This torque is for a steel coupling and a nut of at least grade 8.8 quality. It is compulsory to install a castle nut and cotter pin for right-hand rotation - bi-rotational.

Parker Worldwide

AE – UAE, Dubai
Tel: +971 4 8127100
parker.me@parker.com

AR – Argentina, Buenos Aires
Tel: +54 3327 44 4129

AT – Austria, Wiener Neustadt
Tel: +43 (0)2622 23501-0
parker.austria@parker.com

AT – Eastern Europe, Wiener Neustadt
Tel: +43 (0)2622 23501 900
parker.easteurope@parker.com

AU – Australia, Castle Hill
Tel: +61 (0)2-9634 7777

AZ – Azerbaijan, Baku
Tel: +994 50 2233 458
parker.azerbaijan@parker.com

BE/LU – Belgium, Nivelles
Tel: +32 (0)67 280 900
parker.belgium@parker.com

BR – Brazil, Cachoeirinha RS
Tel: +55 51 3470 9144

BY – Belarus, Minsk
Tel: +375 17 209 9399
parker.belarus@parker.com

CA – Canada, Milton, Ontario
Tel: +1 905 693 3000

CH – Switzerland, Etoy
Tel: +41 (0) 21 821 02 30
parker.switzerland@parker.com

CL – Chile, Santiago
Tel: +56 2 623 1216

CN – China, Shanghai
Tel: +86 21 2899 5000

CZ – Czech Republic, Klecany
Tel: +420 284 083 111
parker.czechrepublic@parker.com

DE – Germany, Kaarst
Tel: +49 (0)2131 4016 0
parker.germany@parker.com

DK – Denmark, Ballerup
Tel: +45 43 56 04 00
parker.denmark@parker.com

ES – Spain, Madrid
Tel: +34 902 33 00 01
parker.spain@parker.com

FI – Finland, Vantaa
Tel: +358 (0)20 753 2500
parker.finland@parker.com

FR – France, Contamine s/Arve
Tel: +33 (0)4 50 25 80 25
parker.france@parker.com

GR – Greece, Athens
Tel: +30 210 933 6450
parker.greece@parker.com

HK – Hong Kong
Tel: +852 2428 8008

HU – Hungary, Budapest
Tel: +36 1 220 4155
parker.hungary@parker.com

IE – Ireland, Dublin
Tel: +353 (0)1 466 6370
parker.ireland@parker.com

IN – India, Mumbai
Tel: +91 22 6513 7081-85

IT – Italy, Corsico (MI)
Tel: +39 02 45 19 21
parker.italy@parker.com

JP – Japan, Fujisawa
Tel: +(81) 4 6635 3050

KR – South Korea, Seoul
Tel: +82 2 559 0400

KZ – Kazakhstan, Almaty
Tel: +7 7272 505 800
parker.easteurope@parker.com

LV – Latvia, Riga
Tel: +371 6 745 2601
parker.latvia@parker.com

MX – Mexico, Apodaca
Tel: +52 81 8156 6000

MY – Malaysia, Shah Alam
Tel: +60 3 7849 0800

NL – The Netherlands, Oldenzaal
Tel: +31 (0)541 585 000
parker.nl@parker.com

NO – Norway, Ski
Tel: +47 64 91 10 00
parker.norway@parker.com

NZ – New Zealand, Mt Wellington
Tel: +64 9 574 1744

PL – Poland, Warsaw
Tel: +48 (0)22 573 24 00
parker.poland@parker.com

PT – Portugal, Leca da Palmeira
Tel: +351 22 999 7360
parker.portugal@parker.com

RO – Romania, Bucharest
Tel: +40 21 252 1382
parker.romania@parker.com

RU – Russia, Moscow
Tel: +7 495 645-2156
parker.russia@parker.com

SE – Sweden, Spånga
Tel: +46 (0)8 59 79 50 00
parker.sweden@parker.com

SG – Singapore
Tel: +65 6887 6300

SK – Slovakia, Banská Bystrica
Tel: +421 484 162 252
parker.slovakia@parker.com

SL – Slovenia, Novo Mesto
Tel: +386 7 337 6650
parker.slovenia@parker.com

TH – Thailand, Bangkok
Tel: +662 717 8140

TR – Turkey, Istanbul
Tel: +90 216 4997081
parker.turkey@parker.com

TW – Taiwan, Taipei
Tel: +886 2 2298 8987

UA – Ukraine, Kiev
Tel: +380 44 494 2731
parker.ukraine@parker.com

UK – United Kingdom, Warwick
Tel: +44 (0)1926 317 878
parker.uk@parker.com

US – USA, Cleveland (industrial)
Tel: +1 216 896 3000

US – USA, Lincolnshire (mobile)
Tel: +1 847 821 1500

VE – Venezuela, Caracas
Tel: +58 212 238 5422

ZA – South Africa, Kempton Park
Tel: +27 (0)11 961 0700
parker.southafrica@parker.com

European Product Information Centre
Free phone: 00 800 27 27 5374
(from AT, BE, CH, CZ, DE, DK, EE, ES, FI, FR, IE, IL, IS, IT, LU, MT, NL, NO, PL, PT, RU, SE, UK, ZA)



Parker Hannifin Ltd.
Tachbrook Park Drive
Tachbrook Park, Warwick CV34 6TU
United Kingdom
Tel.: +44 (0) 1926 317 878
Fax: +44 (0) 1926 317 855
www.parker.com